

# NanoSpeed™ Ultra-Fast 1x1, 1x2, 2X2 Fiber Optical Switch



(8ns rise/fall time, polarization insensitive, all wavelengths, bidirectional, up to 20W)

DATASHEET

[Return to the Webpage](#)



## Features

- Low Loss
- High Reliability
- High Power
- Bidirectional

## Applications

- Laser System
- Quantum System
- Instruments

The NS Ultra-Fast Series (NF) fiber optical switch is based on a patented electro-optical configuration featuring low optical loss, wide temperature operation, and polarization insensitivity. The NS fiber optical switch has ultra-high reliability and can continuously operate for over 25 years in a vibration environment (passed Telcordia and space qualifications). The switch is bidirectional and available with configurations of polarization-independent or polarization-maintain. The rise/fall time is intrinsically related to the crystal properties, and the repetition rate is associated with the driver. The NF Series switch is mounted on an electronic driver having a 5V TTL control signal SMA input and a DC power supplier. There are poor frequency response sections in which the on/off ratio does not meet the spec due to the device's mechanical resonances. The on/off ratio can be optimized for certain frequencies with requests.

The NS series switches respond to a control signal with any arbitrary timing with frequency from DC up to MHz. The switch is usually mounted on a tuned driver prior to shipping. The electrical power consumption is related to the repetition rate the switch is operated.

## Specifications

Parameter	Min	Typical	Max	Unit	
Insertion Loss <sup>[1]</sup>	1900~2200nm	0.8	1.8	dB	
	1260~1650nm	0.6	1.2		
	960~1100nm	0.8	1.3		
	780~960nm	1.2	1.5		
	520~680nm	1.5	2.3		
Cross Talk(On/Off) <sup>[2]</sup>	Single Stage	16	18 <sup>[2]</sup>	25	dB
PDL (SMF Switch only)		0.15	0.3	dB	
PMD (SMF Switch only)		0.1	0.3	ps	
ER (PMF Switch only)	18	25		dB	
IL Temperature Dependency		0.25	0.5	dB	
Return Loss	45	50		dB	
Optical Rise Time (Single Stage only) <sup>[3]</sup>	5	8	10	ns	
Optical Fall Time (Single Stage only) <sup>[3]</sup>	5	8	10	ns	
Minimum Pulse Width		90		ns	
Repetition Rate <sup>[5]</sup>	DC		2	MHz	
Optic Power Handling <sup>[4]</sup>	Normal power version	0.3	0.5	W	
	High power version	5	20	W	
Operating Temperature	Standard	-5	75	°C	
	Special version	-30	85		
Storage Temperature	-40		100	°C	

### Notes:

[1] Measured without connectors. Each connector adds 0.2 to 0.3dB

[2] ± 25nm, The typical cross talk is measured at DC-20kHz and may be degraded at a higher repeat rate.

[3] It is defined as the time it takes for the signal to transition between 10% and 90% of its peak intensity. For wavelengths > 1550 nm, the response is slow due to the limitation of the current driver. At 2000 nm, the rise/fall time is about 20 nanoseconds.

[4] The standard version is defined at 1310nm/1550nm. For the shorter wavelength, the handling is reduced see the graph. High power version has a fiber end beam expander, thus cost more

[5] The driver is optimized at a repeat rate >500kHz. The specs exclude a few resonant frequency points. The performance can be optimized at other frequencies.

**Note:** The specifications provided are for general applications with a cost-effective approach. If you need to narrow or expand the tolerance, coverage, limit, or qualifications, please [click this link](#):

**Warning:** This is an OEM module designed for system integration. Do not touch the PCB by hand. The electrical static can kill the chips even without a power plug-in. Unpleasant electrical shock may also be felt. For laboratory use, please buy a Turnkey system.

**Legal notices:** All product information is believed to be accurate and is subject to change without notice. Information contained herein shall legally bind Agiltron only if it is specifically incorporated into the terms and conditions of a sales agreement. Some specific combinations of options may not be available. The user assumes all risks and liability whatsoever in connection with the use of a product or its application.

Rev 10/29/24

# NanoSpeed™ Ultra-Fast 1x1, 1x2, 2X2 Fiber Optical Switch



(8ns rise/fall time, polarization insensitive, all wavelengths, bidirectional, up to 20W)

## DATASHEET

### Mechanical Dimensions (Unit: mm)

**Package A** Available for normal power 1x1, 1x2 (SM), 2x2 (SM) selected wavelength

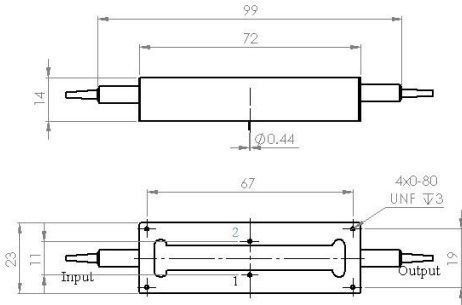

**Package B** For all power, all wavelength SM, PM 1x1, 1x2

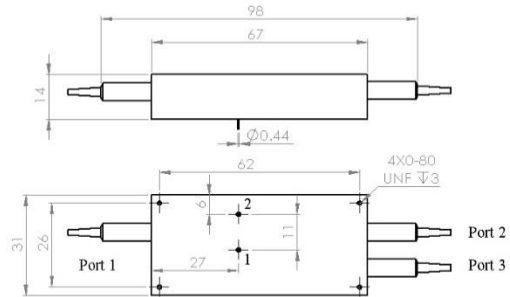

**Packaged with driver**

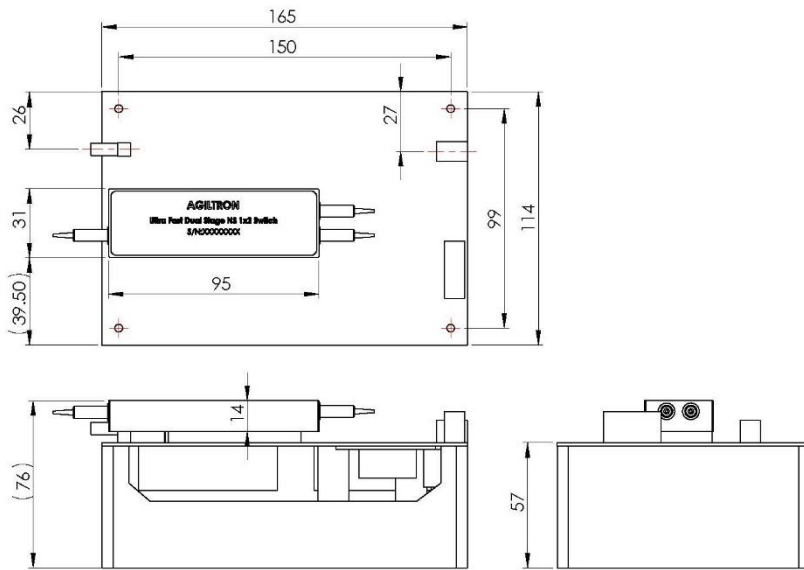

\*Product dimensions may change without notice. This is sometimes required for non-standard specifications.

# NanoSpeed™ Ultra-Fast 1x1, 1x2, 2X2 Fiber Optical Switch



(8ns rise/fall time, polarization insensitive, all wavelengths, bidirectional, up to 20W)

## DATASHEET

### Th Half-Wave Voltage ( $V_{\pi}$ ) Adjustment Guide

The crystal's half-wave voltage ( $V_{\pi}$ ) may vary from the manufacturer setting due to factors such as shipping or operating under different conditions like wavelength and switching frequencies. You can optimize the extinction ratio by adjusting the  $V_{\pi}$  using the instructions below:

1. **Setup:** Connect a laser and a power meter to the switch, and measure the on/off ratio.
2. **Adjustment:** Adjust the potentiometer to increase the extinction ratio or PDL value. Note that different frequency bands have different  $V_{\pi}$ .



The device has a slightly difference  $V_{\pi}$  for different operation frequency bands; therefore, adjustment can optimize the extinction ratio to some extent.

\*Product dimensions may change without notice. This is sometimes required for non-standard specifications.

### Typical Narrow Pulse Generation (90ns at 500kHz)

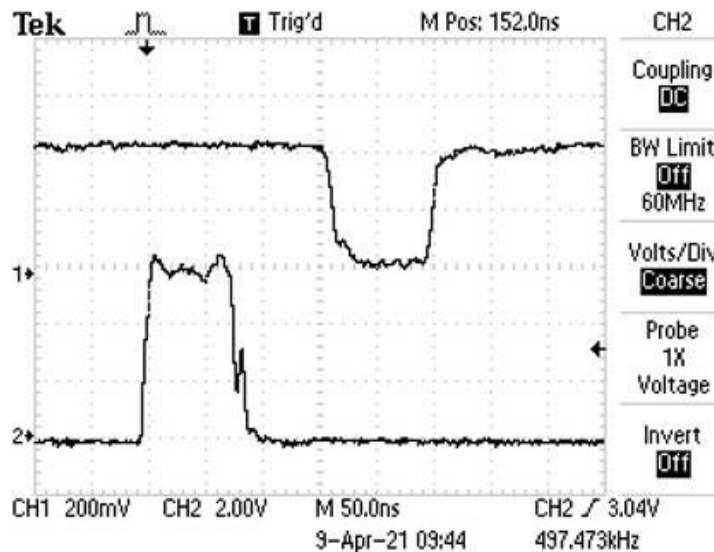

# NanoSpeed™ Ultra-Fast 1x1, 1x2, 2X2 Fiber Optical Switch



(8ns rise/fall time, polarization insensitive, all wavelengths, bidirectional, up to 20W)

## DATASHEET

### Typical Rise and Fall Optical Switching Profile (5ns)

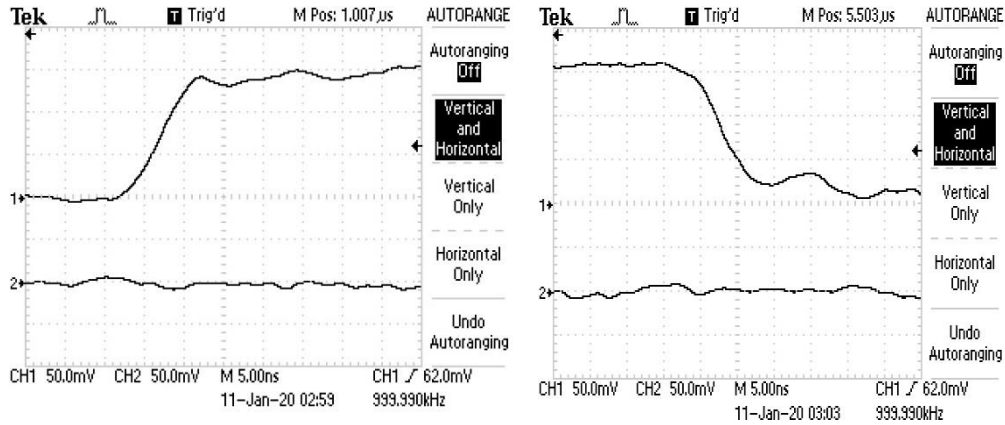

### Typical Optical Switching Repetition Profile (1MHz)

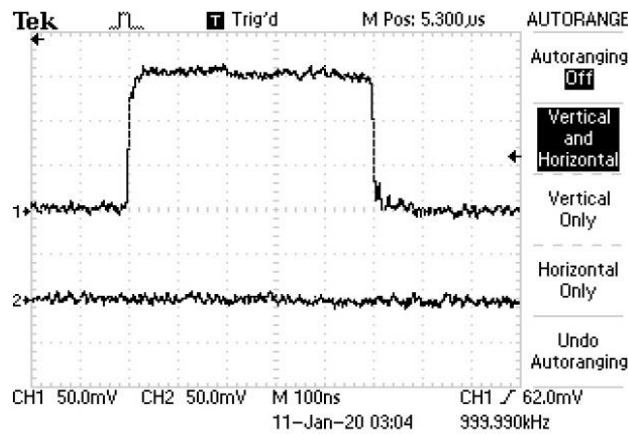

### Typical Switching Response (optical delay ~150ns)

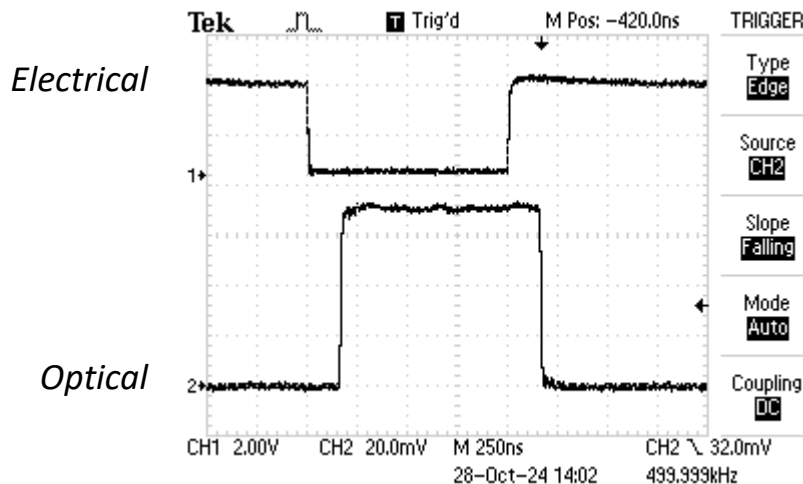

# NanoSpeed™ Ultra-Fast 1x1, 1x2, 2X2 Fiber Optical Switch



(8ns rise/fall time, polarization insensitive, all wavelengths, bidirectional, up to 20W)

## DATASHEET

### Ordering Information

Prefix	Type	Wavelength [1]	Configuration	Repetition Rate	Fiber Type	Fiber Cover	Fiber Length	Connector [4]	Optical Power [5]	Benchtop
NFSW-	1x1 = 11	1060nm = 1	Single stage = 1	900kHz = 6	SMF-28 = 1	Bare fiber = 1	0.25m = 1	None = 1	Regular = R	None = 1
	1x2 = 12	2000nm = 2	Single Stage 5W = H	2MHz [3] = 7	HI1060 = 2	900um tube = 3	0.5m = 2	FC/PC = 2	1W = 1	Benchtop = B
	2x2 [2] = 22	1310nm = 3	Special = 0		HI780 = 3	Special = 0	1.0 m = 3	FC/APC = 3	2W = 2	
		1480nm = 4			PM1550 = 5		Special = 0	ST/PC = 6	3W = 3	
		1550nm = 5			PM850 = 8			LC/PC = 7	5W = 5	
		1625nm = 6			PM980 = 9			LC/APC = A	10W = A	
		780nm = 7			Special = 0			E2000 APC = 9	15W = C	
		850nm = 8						LC/UPC = U	20W = D	
		650nm = E						Special = 0		
		550nm = F								
	Special = 0									

[1]. Red Wavelength Bands are special orders. They use special crystals.

[2]. Ultra-fast 2x2 is made by four pc of 1x2

[3]. Under development. Please call for availability.

[4]. High-power connectors can be ordered as special.

[5]. Only single stage is available for power >1W.

Red Color-marked is special order with a higher price and longer lead time.

#### Note:

- PM1550** fiber works well for **1310nm**, **PM1310** fiber choice costs extra
- Opaque** – light is blocked without applying a voltage
- Transparent** – light goes through without applying a voltage

### Benchtop Box Mechanical Dimension

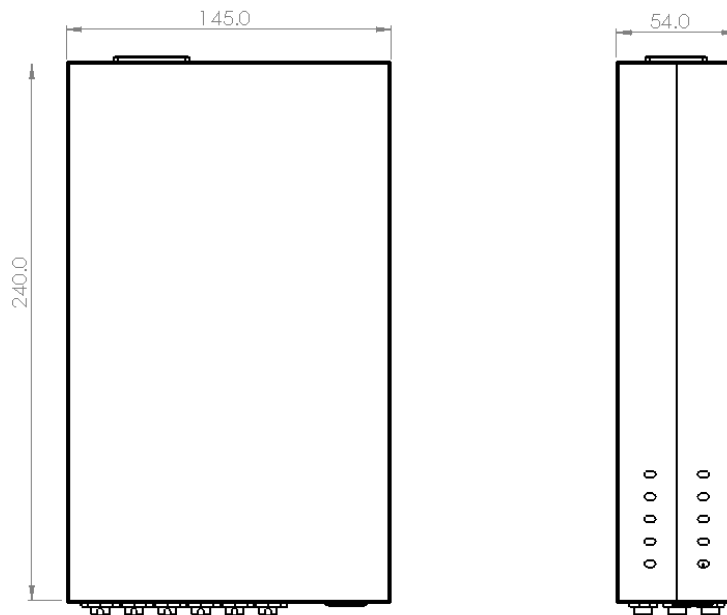

\*Product dimensions may change without notice. This is sometimes required for non-standard specifications.

# NanoSpeed™ Ultra-Fast 1x1, 1x2, 2X2 Fiber Optical Switch



(8ns rise/fall time, polarization insensitive, all wavelengths, bidirectional, up to 20W)

DATASHEET

## Optical Power Handling vs Wavelength For Single-Mode Fibers

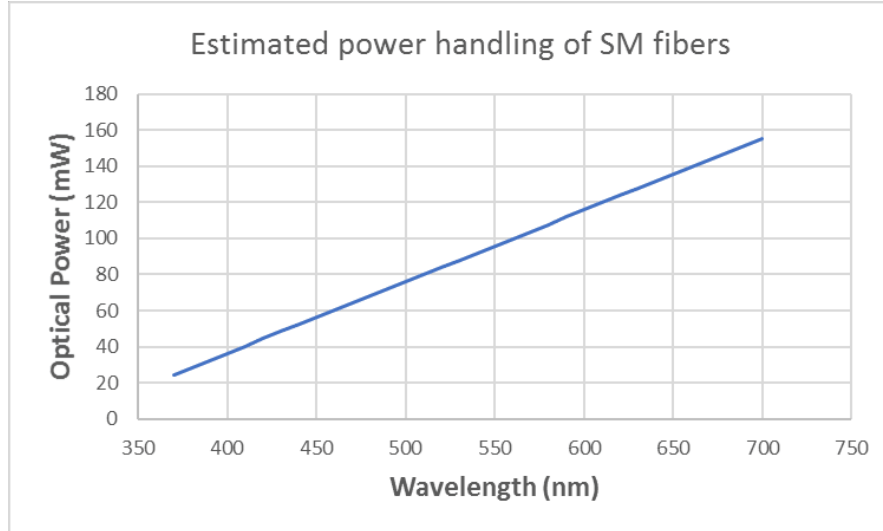

## Typical Wavelength Dependence Profile

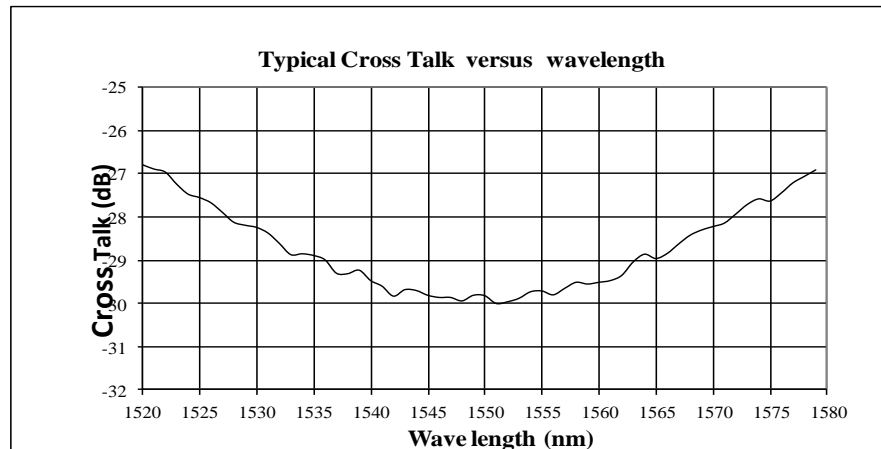

## Electrical Driving Specification

Control signal Input: 0-5V through SMA connector  
Power supply in driver: 110-220 AC  
Power Consumption in driver: <10W

## Operation Manual

1. Connect a control signal to the SMA connector on the PCB.
2. Attach the accompanied power supply (typically a wall-pluggable unit).
3. The device should then function properly.

**Note: Do not alter device factory settings.**

# NanoSpeed™ Ultra-Fast 1x1, 1x2, 2X2 Fiber Optical Switch



(8ns rise/fall time, polarization insensitive, all wavelengths, bidirectional, up to 20W)

## DATASHEET

### Application Notes

---

#### **Fiber Core Alignment**

Note that the minimum attenuation for these devices depends on excellent core-to-core alignment when the connectors are mated. This is crucial for shorter wavelengths with smaller fiber core diameters that can increase the loss of many decibels above the specification if they are not perfectly aligned. Different vendors' connectors may not mate well with each other, especially for angled APC.

#### **Fiber Cleanliness**

Fibers with smaller core diameters (<5  $\mu\text{m}$ ) must be kept extremely clean, contamination at fiber-fiber interfaces, combined with the high optical power density, can lead to significant optical damage. This type of damage usually requires re-polishing or replacement of the connector.

#### **Maximum Optical Input Power**

Due to their small fiber core diameters for short wavelength and high photon energies, the damage thresholds for device is substantially reduced than the common 1550nm fiber. To avoid damage to the exposed fiber end faces and internal components, the optical input power should never exceed 20 mW for wavelengths shorter 650nm. We produce a special version to increase the handling by expanding the core side at the fiber ends.